

DWG. No./Part No.:					CODE:	DESCRIPTION:	MATERIAL:	FINISH:	
N-20					S	HOSE NUT, CGA-022	.6875 HEX BRASS	BRITE-DIP	
REV	ECN	DATE	CHKD	APPVD	TOLERANCES UNLESS SPECIFIED:		NOTICE: THE DATA IN THIS DOCUMENT INCORPORATES PROPRIETARY INFORMATION AND RIGHTS OF SUPERIOR PRODUCTS, INC. CONFIDENCE AND AGREES THAT IT SHALL NOT BE DUPLICATED IN WHOLE OR IN PART, NOR DISCLOSED TO OTHERS WITHOUT THE WRITTEN CONSENT OF SUPERIOR PRODUCTS, INC.	INTERPRET GEOMETRIC TOLERANCING PER: ANSI Y14.5	
A	RDRWN	11/21/05	GDG	MRE	125 FINISH ALL OVER REMOVE ALL BURRS BREAK ALL CORNERS .015/.005 DECIMAL .XX +/- .015 .XXX +/- .005 ANGULAR +/- 1 CONCENTRICITY .007 TIR			DO NOT SCALE	

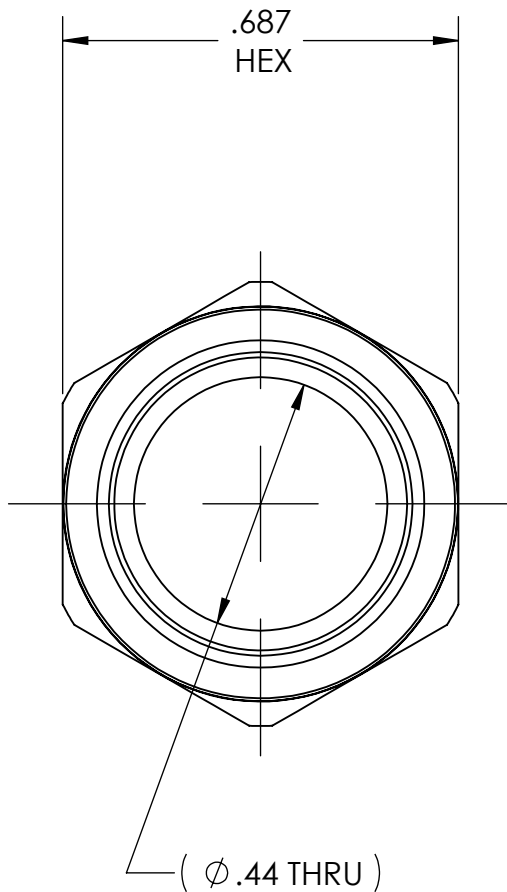

9/16-18 RH UNF
CGA - E1
CONN - 022

