

DWG. No./Part No.: N-59					CODE: S	DESCRIPTION: INLET NUT, CGA-280	MATERIAL: 1.0000 HEX BRASS	FINISH: BRITE-DIP	
REV	ECN	DATE	CHKD	APPVD	<u>TOLERANCES UNLESS SPECIFIED:</u> 125 FINISH ALL OVER REMOVE ALL BURRS BREAK ALL CORNERS .015/.005 DECIMAL .XX +/- .015 .XXX +/- .005 ANGULAR +/- 1 CONCENTRICITY .007 TIR	<u>NOTICE:</u> THE DATA IN THIS DOCUMENT INCORPORATES PROPRIETARY INFORMATION AND RIGHTS OF SUPERIOR PRODUCTS, INC. CONFIDENCE AND AGREES THAT IT SHALL NOT BE DUPLICATED IN WHOLE OR IN PART, NOR DISCLOSED TO OTHERS WITHOUT THE WRITTEN CONSENT OF SUPERIOR PRODUCTS, INC.	INTERPRET GEOMETRIC TOLERANCING PER: ANSI Y14.5		
A	RDRWN	11/08/05	GDG	MRE			DO NOT SCALE		

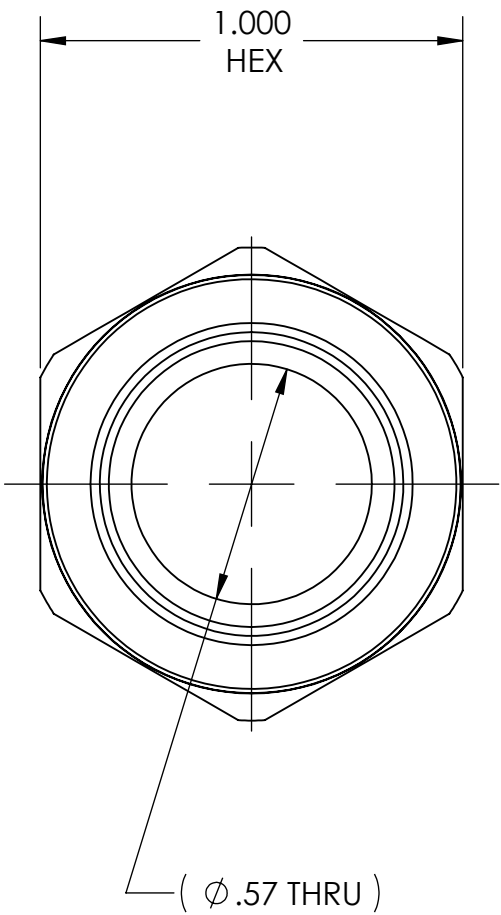

.750-14 RH NGO
CGA- V1
CONN - 280

